

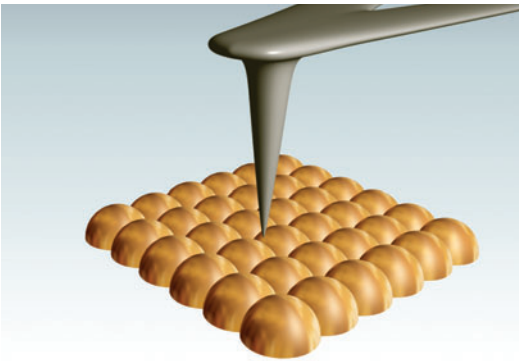

Breaking barriers of routine SPM



Extremely high stability of SPM

AFM, STM, lithography, nanomanipulation and many more techniques can be performed on areas smaller than 100x100 nm for hours! Moreover the closed loop control is available even for atomic lattice imaging. **NTEGRA Therma.**

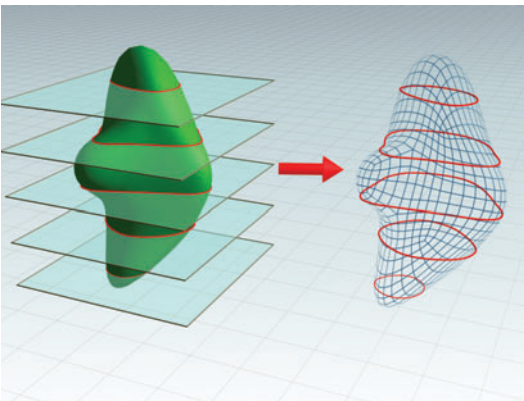

AFM-based tomography

Advantages of AFM combined with ultramicrotome. Serial AFM images obtained sequentially with ultramicrotome sectioning are then reconstructed into 3D model of the object inner structure. **NTEGRA Tomo.**

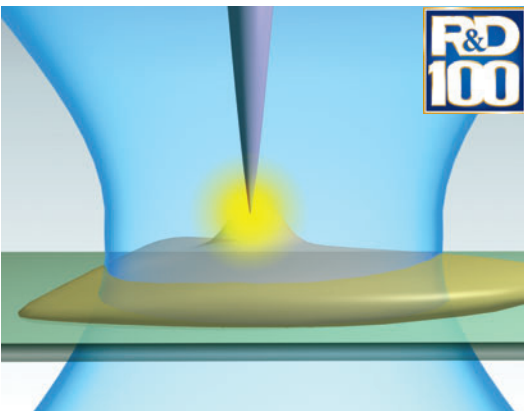

Raman microscopy with ultra-high resolution

Precise positioning of the special AFM probe into the focused laser spot enables more than thousand-times enhancement of Raman signal from the object (so called Tip-Enhanced Raman Scattering – TERS). Single molecules can now be Raman visible this way.

NTEGRA Spectra - winner of R&D100 award 2006.



Breaking barriers of routine SPM

Stability of SPM experiments. NTEGRA Thermo

Almost every specialist in SPM community has been faced in his (her) experience with failures caused by mutual displacement of sample and probe. This effect arises either from mechanical or thermal drifts inside the AFM system. The consequences could be fatal for whole experiment especially for small scan areas (less than 1 μm).

Mechanical drift caused by piezoceramics properties.

Even best piezoceramics devices suffer from hysteresis, creep and non-linearity. The only way to have the system with ultimate repeatability is to apply a special software and closed-loop (CL) correction. In practice CL sensors always put some noise into the system therefore almost all commercially available SPMs do not allow working on the fields smaller than 500 nm with closed-loop correction.

Proposed solution: special design of NTEGRA Thermo measuring head gives the opportunity to maintain ultra high stability and reproducibility of probe movement. Scanner sensors of NTEGRA Thermo have the lowest noise level among commercially available instruments. The engineering solutions make the hardware correction possible on the areas as small as 50 nm. In fact even atomic lattice can be imaged with CL sensors switched on!

Thermal drift caused by non-uniform thermal expansion of SPM parts.

One can easily find temperature noise of 3-5°K magnitude even in the room with climate control. SPM also produces some heat during its operation. Typical values of thermal drift in commercially available SPMs are tens of nanometers per hour. The wider is the temperature range of experiment the more prominent becomes thermal drift influence. The drift about hundreds of nanometers per K becomes a rule for usual SPM.

Proposed solution: NTEGRA Thermo incorporates unique design solutions to fight against the thermal drift. Thoroughly developed system geometry, special combination of materials with similar coefficients of thermal expansion and conductivity, precise stabilization of the scanning module temperature, and some other features enable XY drifts at room temperature as small as 3-5 nm/hour, and about 10 nm/K at changing temperature!

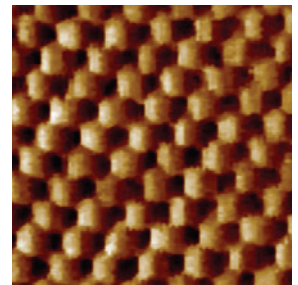

Atomic lattice of HOPG obtained at extremely low scan rate (about 1 line/sec)

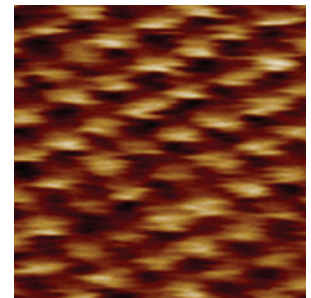

Atomic lattice of mica as imaged with closed loop correction.

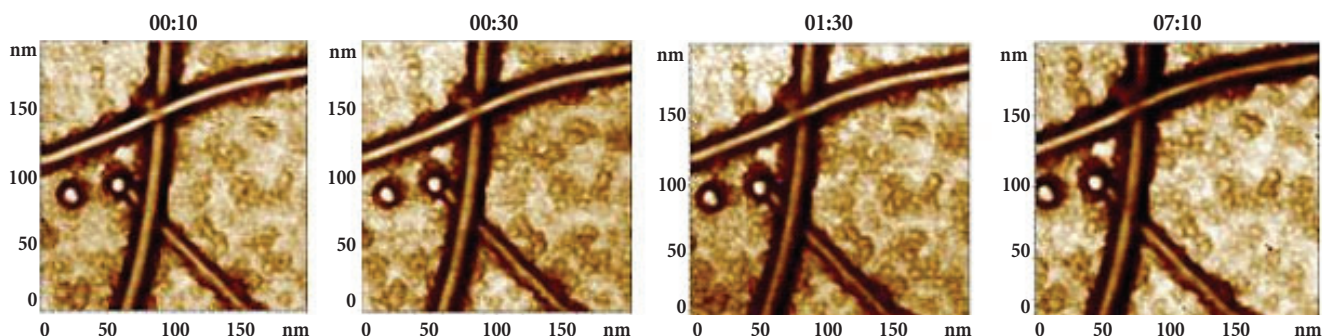

Nanotubes and nanoparticles in long-term experiment . Overall displacement for 7 hours is about 35 nm. Sample courtesy of Dr. H. B. Chan, Department of Physics, University of Florida, USA.



Breaking barriers of routine SPM

AFM based tomography. NTEGRA Tomo

AFM tomography is a method based on both atomic-force microscopy (AFM) and ultramicrotomy. It allows one to study inner properties of almost any polymer material including rather hard ones. 3D reconstruction can be performed after serial AFM imaging of the block face combined with sectioning by an ultramicrotome.

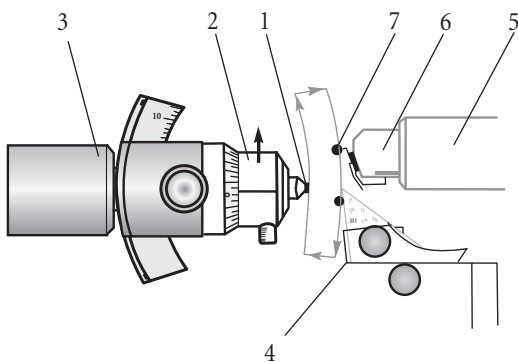

Principle scheme of the AFM tomography setup:

- | | |
|--------------------------------|------------------|
| 1 – sample | 5 – AFM scanner |
| 2 – sample holder | 6 – probe holder |
| 3 – movable ultramicrotome arm | 7 – AFM probe |
| 4 – ultramicrotome knife | |

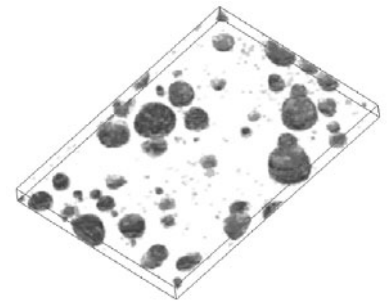
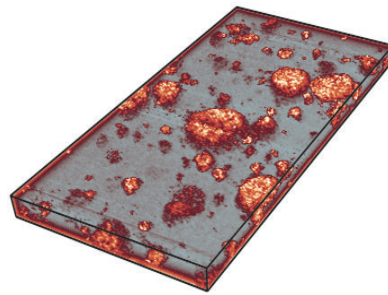

Silica nanoparticles within polymer matrix (nanocomposite material). Each individual image size is $20 \times 40 \mu\text{m}$, spaces are 200 nm. Sample courtesy of Dr. Aliza Tzur, Technion, Israel.

3D Model of multicomponent polymer blend. Model size $8.0 \times 5.6 \times 0.6 \mu\text{m}$, spaces between sections 40 nm. Sample courtesy of Dr. Christian Sailer, Institut f. Polymere, ETH-Honggerberg, Switzerland.

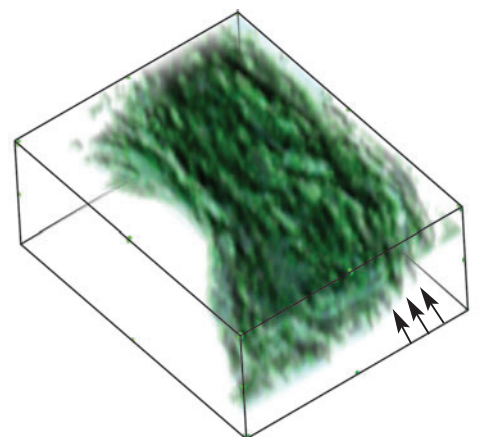
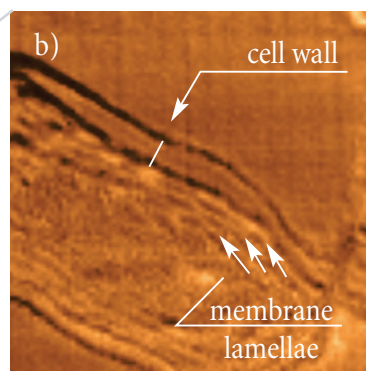
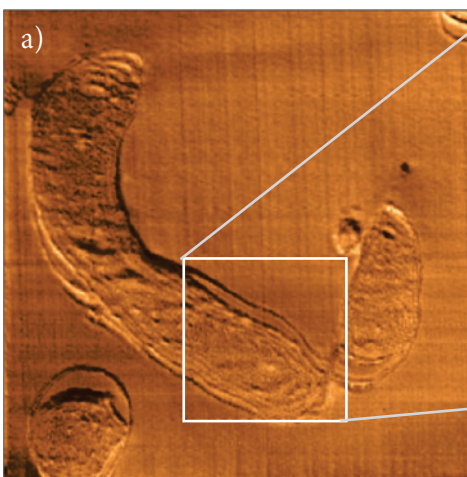

AFM tomography of resin embedded cyanobacteria. Photosynthetic membrane lamellae are clearly seen both on enlarged AFM image and on a 3D model ($4.9 \times 4.6 \times 0.9 \mu\text{m}$, spaces between sections 50 nm). Sample courtesy of Dr. N. Matsko, ETH, Zurich, Switzerland.



Breaking barriers of routine SPM

SPM + confocal microscopy/spectroscopy: advantages of combination

Combination of SPM and confocal microscopy/spectroscopy allows to carry out simultaneous physical and chemical characterization of the same area on sample surface. **NTEGRA Spectra** has successfully integrated AFM, SNOM (near-field optical microscopy), Raman and fluorescence microscopy and spectroscopy techniques.

Moreover, unique nonlinear optical effects arising due to interaction of light with an SPM probe produce giant enhancement of Raman and fluorescence signals. TERS (tip-enhanced Raman scattering) experiments become possible due to precise spatial coordination of a special AFM tip and focused laser spot. Optical characterization can now be performed with resolution far beyond the diffraction limit.

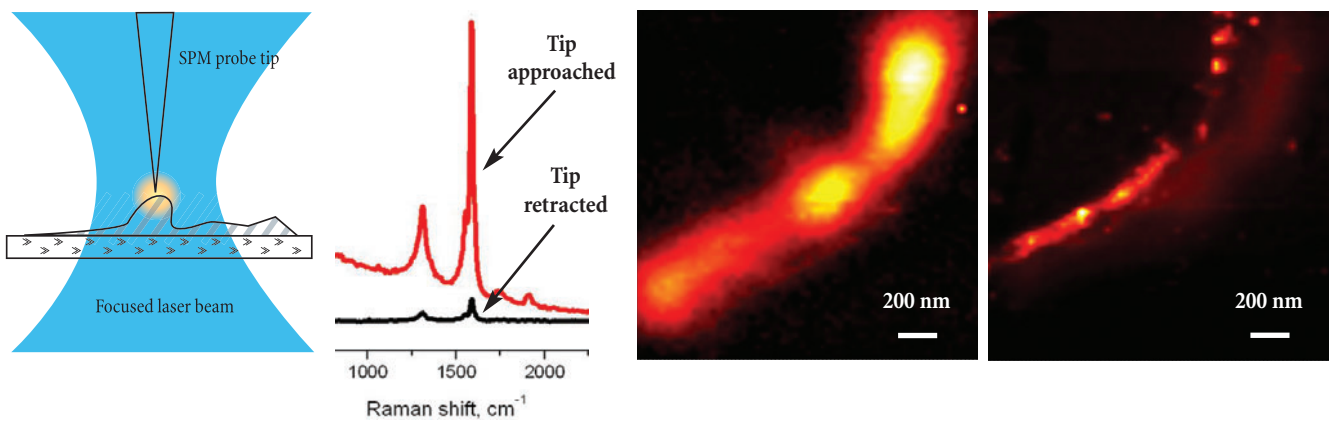

Raman microscopy with ultra-high spatial resolution. A - tip enhanced Raman scattering experiment, B - intensity of carbon nanotube G-band increases by several orders of magnitude when the probe tip is landed, C - confocal Raman image of carbon nanotube bundle. D- tip-enhanced Raman scattering (TERS) image of the same nanotube bundle. Note, TERS provides more than 4-times better spatial resolution as compared to confocal microscopy. Data courtesy of Dr. S. Kharintsev, Dr. J. Loos, TUE, the Netherlands and Dr. P. Dorozhkin, ISSP RAS, Russia.

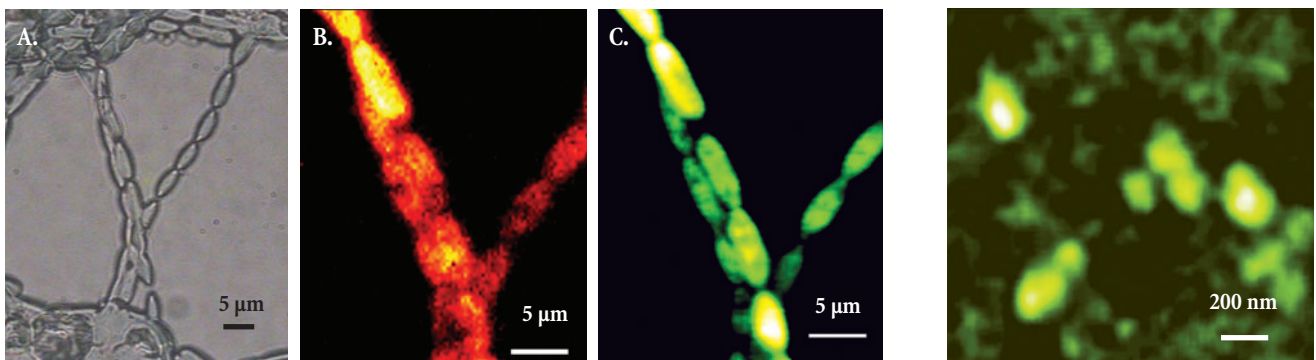

Microalgae seen by bright field microscopy (A), Raman microscopy at beta-carotene line (B), and confocal microscopy of autofluorescence (C). Sample courtesy of Dr. Don McNaughton, Monash University, Victoria, Australia.

SNOM image of mitochondria dyed with FITC-labeled antibodies. Note XY resolution beyond the diffraction limit.